

INTRODUCTION

The single point, all purpose duct/immersion temperature transmitter utilizes a precision sensor that is encapsulated in 6 mm (0.236") OD, 304 series stainless steel probe and is available in various lengths. All probes provide excellent heat transfer, fast response, and resistance to moisture penetration. A transmitter that provides a high accuracy signal with excellent long term stability, low hysteresis, and fast response. It is available with various ranges. A compact polycarbonate enclosure with a hinged and gasketed cover is provided for ease of installation.

BEFORE INSTALLATION

Read these instructions carefully before installing and commissioning the temperature transmitter. Failure to follow these instructions may result in product damage. Do not use in an explosive or hazardous environment, with combustible or flammable gases, as a safety or emergency stop device or in any other application where failure of the product could result in personal injury. **Do not exceed the device ratings.**

MOUNTING (DUCT)

The temperature transmitter installs directly into any air duct with several lengths available for a wide range of duct widths/diameters. Select a suitable installation area in the middle of the duct wall. To achieve the best reading, do not place in an area where air stratification may be present. Mount the sensor at least 1.5 m (5') in either direction from elbows, dampers, filters or other duct restrictions. Avoid areas where the sensor is exposed to vibrations or rapid temperature changes.

Once a suitable spot is selected, drill a 9.5 - 12 mm (3/8" - 1/2") hole for the probe.

Slide the probe in the drilled hole until the enclosure is flush against the duct. The airflow direction is not important. Secure the enclosure to the duct with two #10 x 25 mm (1") self tapping screws (not provided). Tighten screws until the enclosure is tight against the duct and there is no movement of the enclosure as shown in Figure 1.

A foam gasket on the back of the enclosure provides a tight seal against any air leaks.

MOUNTING (IMMERSION)

The temperature sensor must be installed into a thermowell. Failure to use a thermowell will create leaks and could damage the sensor. Install the thermowell as recommended in Figure 2. For complete thermowell installation instructions, please refer to installation instructions provided with the thermowell.

It is recommended to use heat conductive compound. Prior to installing the sensor inject a liberal amount into the thermowell and/or on the tip of the sensor. Slide the probe into the thermowell until it makes contact with the bottom of the thermowell. Tighten set screw to secure probe in thermowell. See Figure 3.

The enclosure has a hinged cover with a latch. Open the cover by pulling slightly on the latch on the right side of the enclosure, at the same time pulling on the cover, as illustrated in Figure 4.

A 1/2" NPT threaded connection hole is provided in the bottom of the enclosure. Screw the EMT connector or cable gland connector in until tight. See Figure 5. It is recommended that weatherproof conduit or cable gland fittings be used. The F style enclosure includes 1/2" NPT to M16 thread adapter and cable gland fitting.

Make wiring connections as per the "Wiring" illustrations on Page 2.

Swing door closed until securely latched. For added security, 2 screws are provided that may be installed in the integrated screw tabs. See Figure 6.

Figure 1

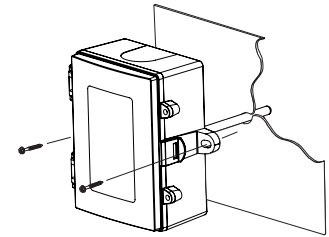

Figure 2

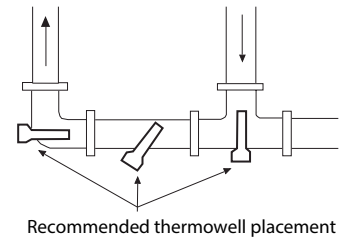

Figure 3

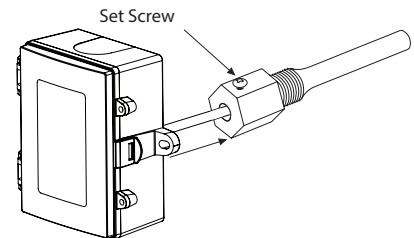

Figure 4

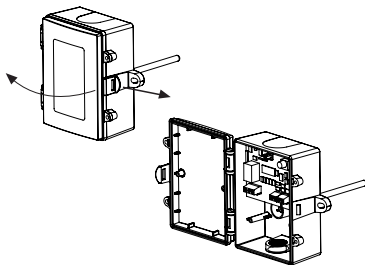

Figure 5

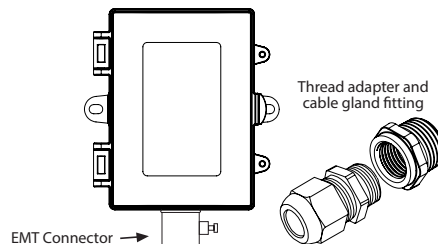
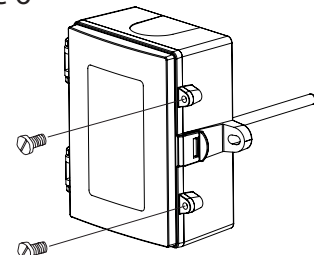
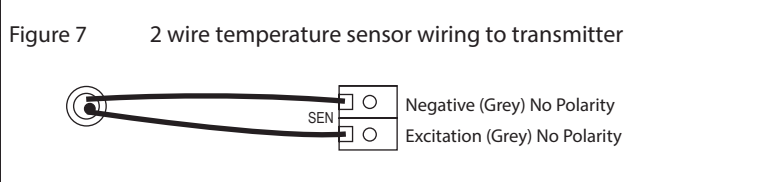
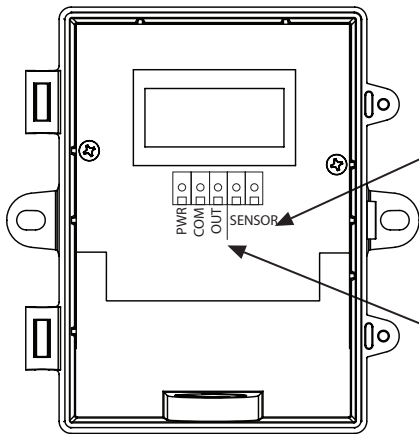

Figure 6



WIRING

- Deactivate the 24 Vac/dc power supply until all connections are made to the device to prevent equipment damage.
- Use 14-22 AWG shielded wiring for all connections and do not locate the device wires in the same conduit with wiring used to supply inductive loads such as motors. Make all connections in accordance with national and local codes.
- The temperature transmitter comes with the temperature sensor pre-wired to the transmitter board. If removal is required for installation then it may be re-wired as shown in Figure 7.
- Pull at least six inches of control wire into the enclosure, then complete the wiring connection according to the wire diagram for the applicable power supply and output signal type as shown in Figure 8.
- Connect the DC positive or the AC voltage hot side to the PWR terminal. For voltage output or AC power, the supply Common is connected to the COM terminal. The device is reverse voltage protected and will not operate if connected backwards. It has a half-wave power supply so the supply Common is the same as the signal Common. See Figure 8.
- The analog output is available on the OUT terminal. Check the controller Analog Input to determine the proper connection before applying power as shown in Figure 8.
- Once all connections are made and checked, power can be applied.



SPECIFICATIONS:

Sensor Type:.....1000 ohm platinum RTD
 Sensor Accuracy:.....±0.3°C (±0.94°F) @ 0°C (32°F)
 Wire Material:.....PVC insulated, parallel bonded, 22 AWG
 Probe Sensing Range:.....-40 to 100°C (-40 to 212°F)
 Probe Material:.....304 Series stainless steel
 Probe Diameter:.....6 mm (0.236")
 Wire Material:.....PVC insulated, parallel bonded, 22 AWG
 Standard lengths:.....50, 100, 150, 200, 300 and 450 mm
 (2", 4", 6", 8", 12" and 18")
 Output Signal:.....4-20 mA current loop, 0-5 vdc, or 0-10 vdc
 (factory configured)
 Transmitter Accuracy:.....±0.2% of span, including linearity
 Power Supply:.....15 to 30 Vdc, 12 to 28 Vac
 Consumption (max):.....20 mA for current, 11 mA for voltage
 Protection Circuitry:.....Reverse voltage protected and output limited
 Output Drive @ 24 Vdc:.....700 ohms max for current output,
 20K ohms min for voltage output
 LCD Display Units:.....°C or °F (factory configured)
 Display Range:.....3 digit for -88.8 to 888 as required
 Display Size:.....38.1 mm W x 16.5 mm H (1.5" to 0.65")
 Digit Height:.....11.4 mm (0.45") plus °C/°F symbol
 Ambient Operating Range:.....0 to 50°C (32 to 122°F), 0-95 %RH
 Enclosure:.....Grey polycarbonate UL94-V0, IP65 (NEMA 4X)
 F style includes thread adapter (1/2" NPT to M16)
 and cable gland fitting
 Wiring Connections:.....Screw terminal block (14 to 22 AWG)
 Country of Origin:.....Canada

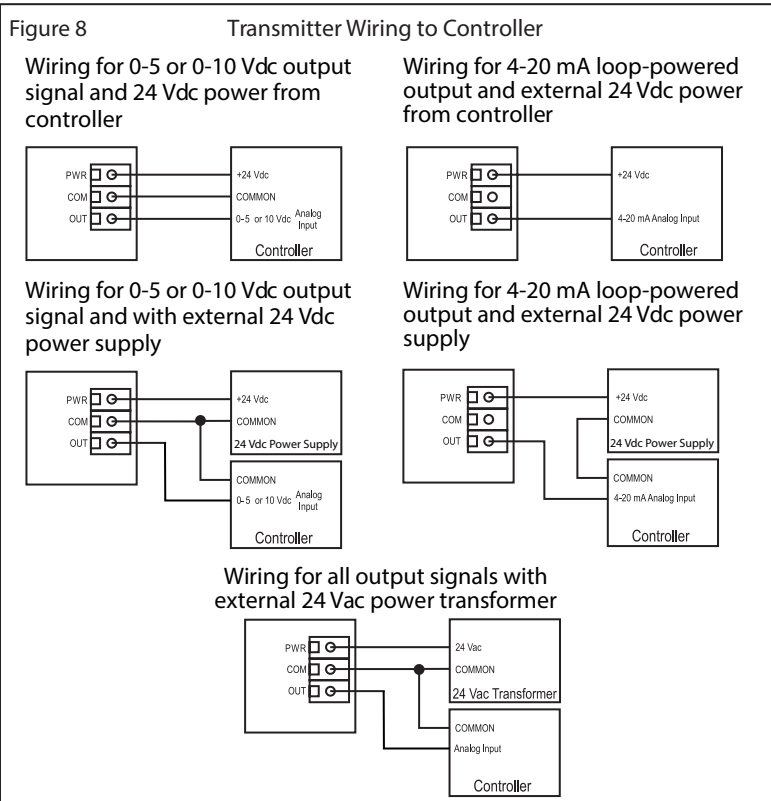

DIMENSIONS

