

INTRODUCTION

The Air Flow and Velocity Transmitter series is intended for use in commercial environments. It is designed with a duct mount probe and adjustable collar suitable for round or rectangular ducts. The transmitter provides separate readings for air velocity and temperature. It comes with three measurement ranges in a single device (0–2 m/s, 0–10 m/s, 0–20 m/s) and is available with optional display and relay.

BEFORE INSTALLATION

Read these instructions carefully before attempting to install, operate or service this device. **Failure to observe safety information and comply with instructions can result in personal injury, death and/or property damage.** Disconnect power before installing or servicing device and only use wiring with insulation rated for full device operating voltage. **Not for use in flammable or explosive environments.**

MOUNTING

The transmitter should be mounted in an easily accessible location in a straight section of duct at least five feet from corners or other items that may cause disturbances in the air flow. Avoid areas where the detector is exposed to vibrations or rapid temperature changes.

Once a suitable location is selected, use the mounting flange as a template and mark the locations of the two screws needed to mount the transmitter. Pre-drill the holes in the duct and mount the flange with screws (not included). See Figure 1.

Adjust the probe to the desired depth. Ensure that the end of the probe reaches the middle of the duct. Tighten the screws on the flange to hold the probe in position. See Figure 2.

For proper mounting orientation in relation to air flow direction, see Figure 3.

WIRING

For CE compliance a properly grounded shielding cable is required. Unscrew the strain relief and route the cable(s). Use the strain relief on the left for power in and signal out. Connect the wires as shown in Figure 4 and then tighten the strain relief.

Select the desired measurement range by installing the jumpers as shown in Figure 5.

To configure the temperature output (Tout) and velocity output (Vout) select the output mode, current (mA) or voltage (V), by installing the jumpers as shown in Figure 6. Both output types are configured separately.

To configure the switching point (display required) install a jumper to pins labeled sw.p. (switching point) as shown in Figure 7. Press down on the

Figure 1

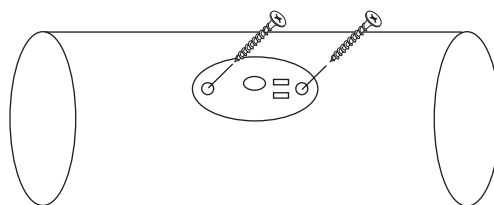

Figure 2

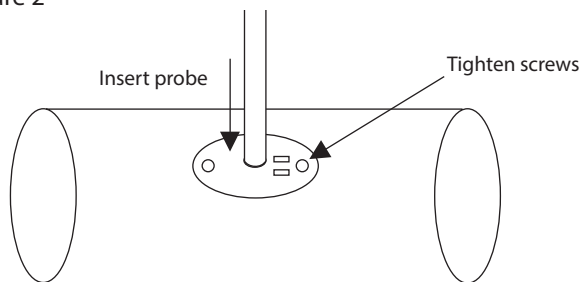

Figure 3

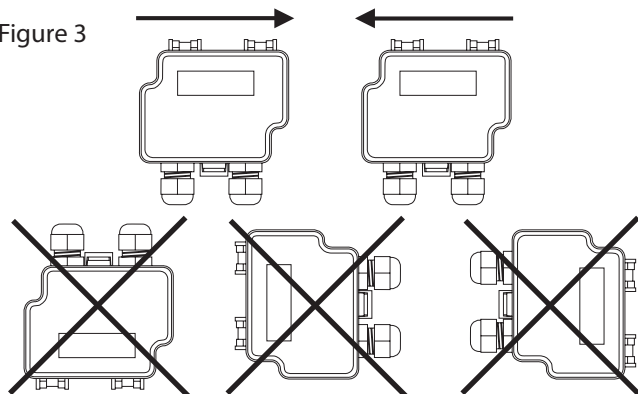

Figure 4

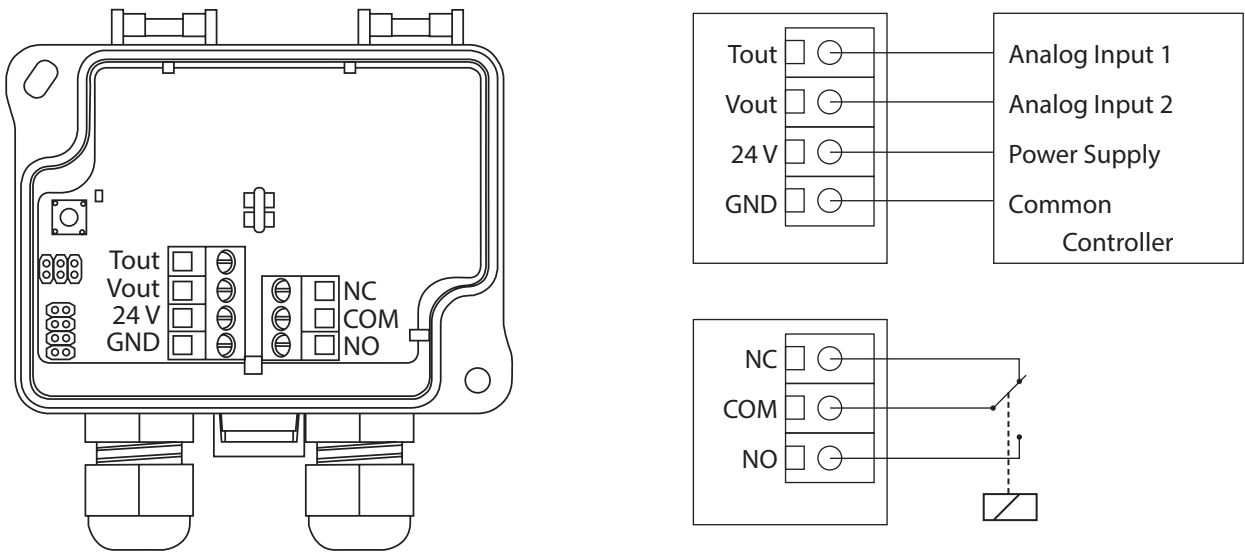
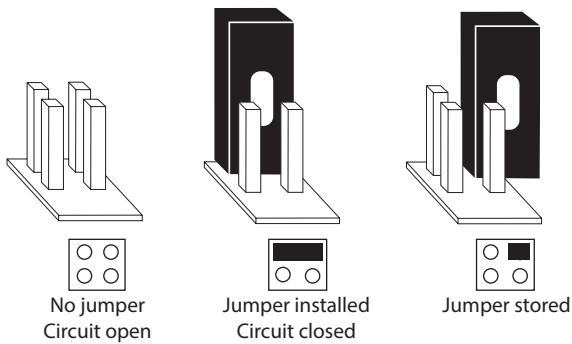

Figure 5

Jumper Placement



Range 2 (0-2 m/s)

- J1 Jumper (J1): Installed
- J2 Jumper (J2): Not installed

Range 10 (0-10 m/s)

- J1 Jumper (J1): Not installed
- J2 Jumper (J2): Installed

Range 20 (0-20 m/s)

- J1 Jumper (J1): Installed
- J2 Jumper (J2): Installed

Figure 6

- Temperature output (Tout): T = voltage (V)
Velocity output (Vout): V = voltage (V)
V mA
- Temperature output (Tout): T = current (mA)
Velocity output (Vout): V = current (mA)
V mA
- Temperature output (Tout): T = voltage (V)
Velocity output (Vout): V = current (mA)
V mA
- Temperature output (Tout): T = current (mA)
Velocity output (Vout): V = voltage (V)
V mA

Figure 7

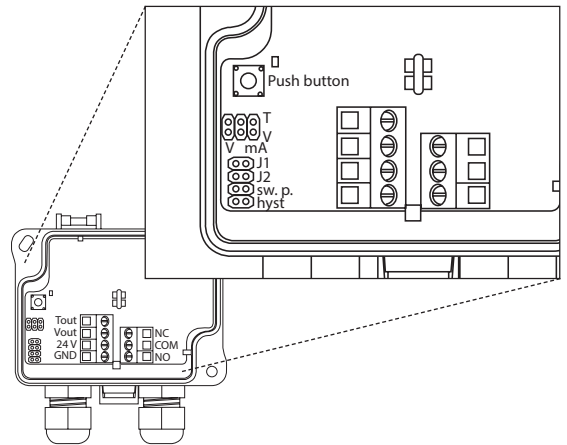

pushbutton to select the switching point (e.g. 5.05 m/s = NC) of the relay. The chosen value (m/s) is shown on the display. Remove and store the jumper after the configuration is complete.

To configure the hysteresis (display required) install a jumper to pins labeled hyst. as shown in Figure 7. Press down on the pushbutton to select the hysteresis of the relay switching point. The chosen value (m/s) is shown on the display. Remove and store the jumper after the configuration is complete. The hysteresis maximum setting is based on the range selected.

NOTE: The configuration jumpers must be removed and stored for proper operation.

SPECIFICATIONS

Velocity Ranges.....	Base & Metric Models: 0-2m, 10 & 20m/s, field selectable Imperial Model: 0-400, 2000 & 4000 fpm, field selectable
Velocity Accuracy	Metric: Range - 0...2 m/s: <0.2 m/s + 5% from reading Range - 0...10 m/s: <0.5 m/s + 5% from reading Range - 0...20 m/s: <1.0 m/s + 5% from reading Imperial: Range - 0...400 fpm: <20 fpm + 5% from reading Range - 0...2000 fpm: <100 fpm + 5% from reading Range - 0...4000 fpm: <200 fpm + 5% from reading
Thermal Shift.....	±0.8 %FS / °C
Calibration	Units calibrated at 22°C (71.6°F) Rapid thermal shift stabilization time 10 min.
Temperature Range	0 to 50°C (32 to 122°F)
Temperature Accuracy	<0.5°C for velocity >0.5 m/s (<0.9°F for V > 100 fpm)
Operating Conditions	0 to 50°C (32 to 122°F), 0 to 95 %RH, non-condensing
Storage Temperature	-20 to 70°C (-2 to 158°F)
Media Compatibility.....	Dry air or non-aggressive gases
Output Signal 1 (Tout)	0-10 V (linear to temperature) L min 1K Ω 4-20 mA (linear to temperature) L max 200 Ω
Output Signal 2 (Vout).....	0-10 V (linear to m/s) L min 1K Ω 4-20 mA (linear to m/s) L max 400 Ω
Optional Relay Out.....	Potential free SPDT (NC, COM, NO) 250 Vac, 6A / 30 Vdc, 6A adjustable switching point and hysteresis
Power Supply	24 Vdc / 24 Vac ±10%
Current Consumption.....	Current: 75 mA (90 mA with relay) Voltage: 35 mA (90 mA with relay)
Optional Display	4 digit LCD backlit display Size: 45.7mm W x 12.7mm H (3.5" x 0.5")
Display Units	Metric: m/s and °C Imperial: fpm and °F
Enclosure	Case: ABS Cover: Polycarbonate Ratings: IP54 (NEMA 3) Probe: 304 series stainless steel Mounting Flange: LLPDP
Dimensions.....	Case: 90mm W x 71.5mm H x 36mm D (3.5" x 2.8" x 1.4") Probe: OD 10mm (0.394"), length 210mm (8.26") from bottom of cover
Mounting.....	Mounting flange, Ø4mm (11/64")
Insertion Lenth with Flange ..	Adjustable 50-180mm (2"-7.08")
Electrical Connections	Power Supply & Signal Out: 4-screw terminal block 12-24 AWG (0.2-1.5mm ²) Relay Out: 3-screw terminal block 12-24 AWG (0.2-1.5 mm ²)
Cable Entry	M16 (0.625") cable gland
Weight	220g (7.76oz)
Approvals	CE, RoHS
Country of Origin.....	Finland

DIMENSIONS

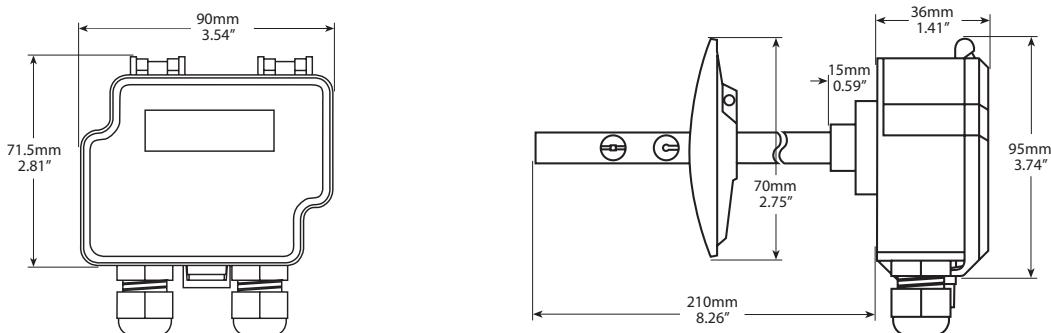

PRINTED IN CANADA